

OWNER'S MANUAL

PLEASE READ CAREFULLY BEFORE
USING THIS PRODUCT.

10.1" DIGITAL 3CH LCD ALL ROUND VISION MONITOR

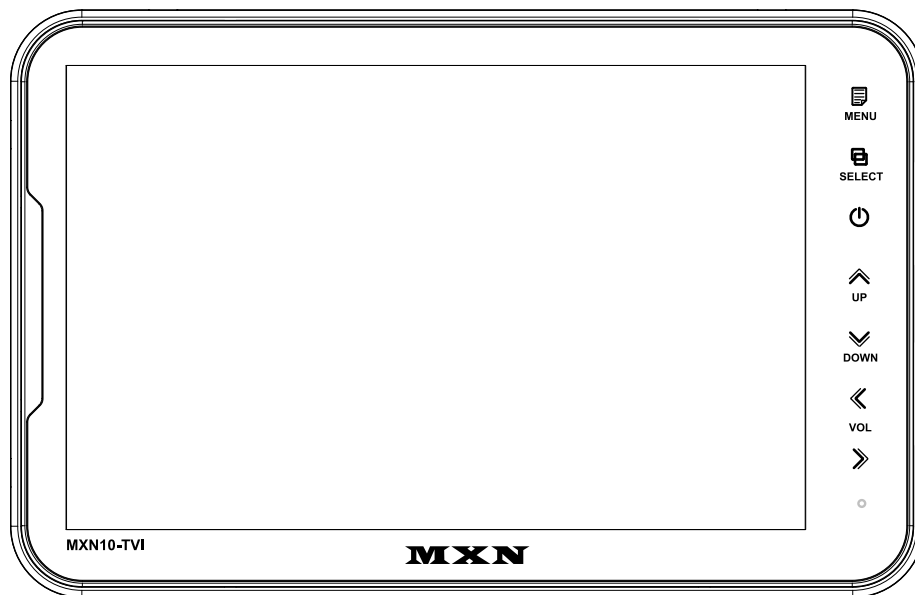

Model: MXN10-TVI

Design and specifications are subject to change without notice.

INDEX

PACKAGE CONTENTS	03
------------------	----

OPERATION	04
-----------	----

SYSTEM SETTINGS	
MENU STRUCTURE	05
FUNCTION	06
PICTURE MENU	07
NORMAL/MIRROR	07
AUDIO	08
TRIGGER AUDIO	08
CAMERA TRIGGER	09
DISTANCE MARKER	09
MARKER	09
DISTANCE MARKER ADJUSTMENT	10
AUTO PICTURE SCAN	11
CAMERA NAME	11
SPEED SWITCH	12

MENU	
SPLIT	13
MANUAL SELECTION	13
MENU LOCK ON/OFF FUNCTION	14
AUTO PICTURE SCAN ON/OFF FUNCTION	14

CONNECTIONS	
CAMERA INPUT	15

INSTALLATION	
BRACKET	16
INSTALLATION OF HEAVY DUTY MOUNTING BRACKETS	17

SPECIFICATIONS	18
----------------	----

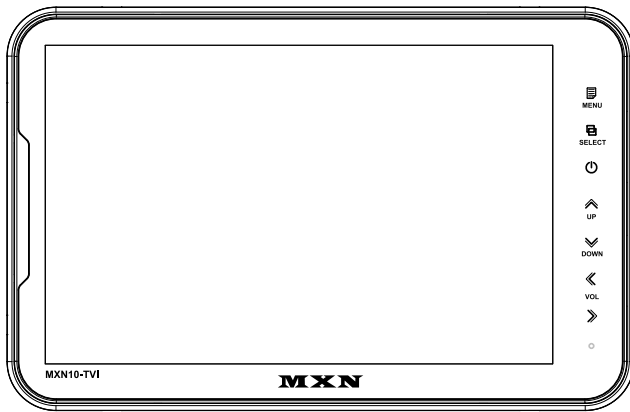

MONITOR

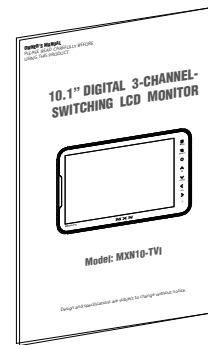

MANUAL

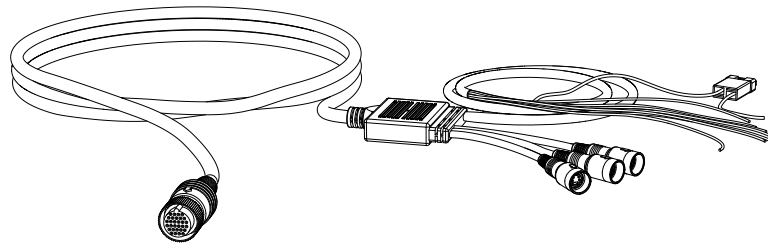

CAMERA INPUT CABLE

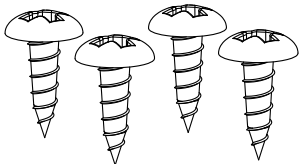

BRACKET SCREWS

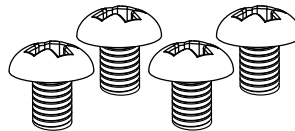

MOUNT SCREWS

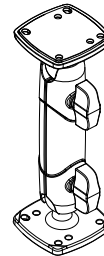

HEAVY DUTY MOUNT

ITEM	Q'TY
MONITOR	1
CAMERA INPUT CABLE	1
HEAVY DUTY MOUNT	1
MOUNT SCREWS (Machine Screw, M5 / 12mm) PH M5x12	4
BRACKET SCREWS (Tapping Screw, M5 / 25mm) TH 1, M5x25	4
MANUAL	1

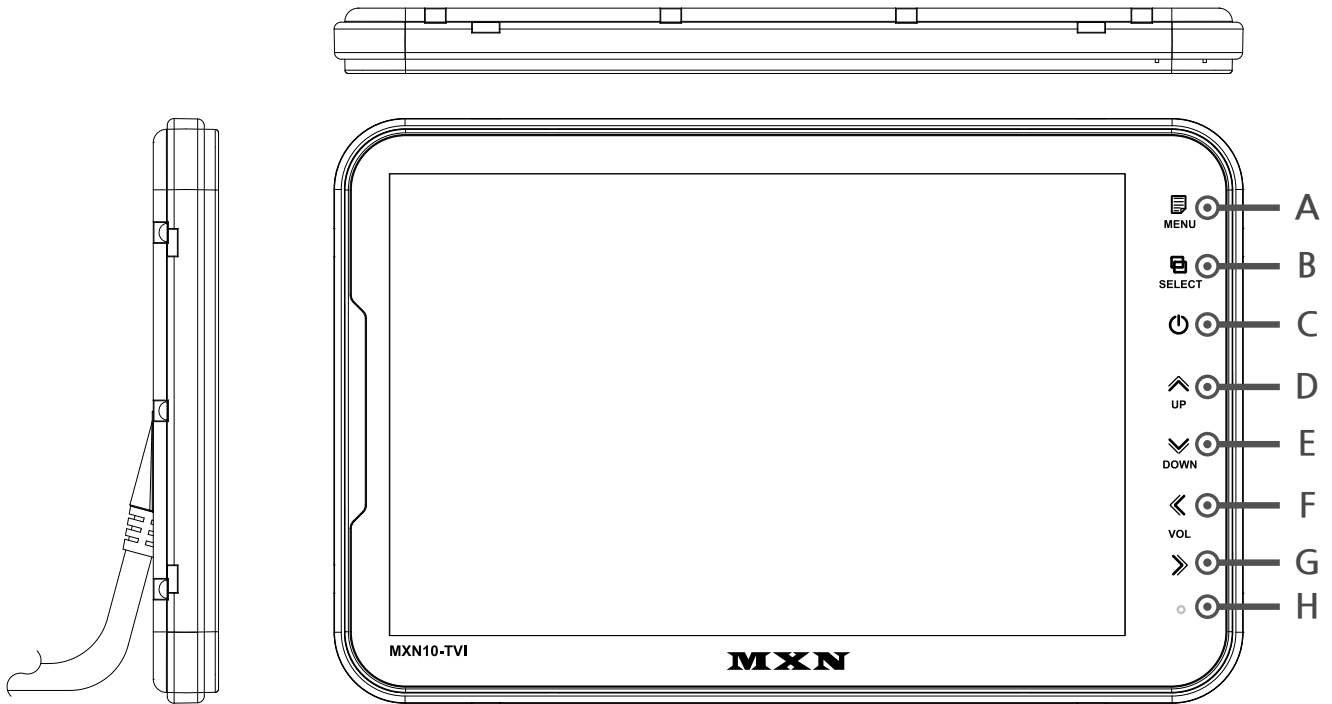
**A. MENU**

Press [MENU] button for system settings.

B. SELECT

Press [SELECT] button to select the respective channel.
[CAM1 - CAM2 - CAM3 - SPLIT].

C. POWER

Press [POWER] button to turn on/off the monitor.

D. UP

Press [UP] button to navigate the menu for system settings.

E. DOWN

Press [DOWN] button to navigate the menu for system settings.

F. LEFT

Press [LEFT] button to adjust the monitor volume.
Use [LEFT] button to change OSD setting during system settings.

G. RIGHT

Press [RIGHT] button to adjust the monitor volume.
Use [RIGHT] button to change OSD setting during system settings.

H. DAY/NIGHT SENSOR (CDS)

Automatic brightness control sensor

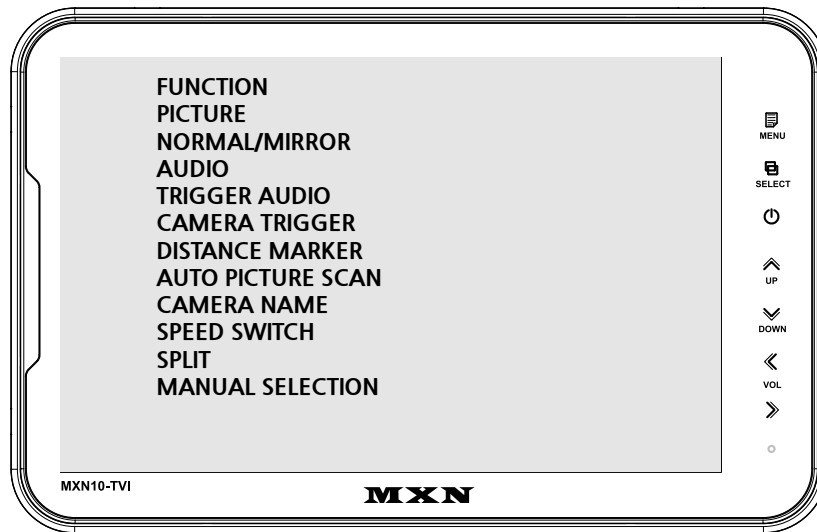

MENU STRUCTURE

Change the setting value by pressing the MENU button.

FUNCTION

Set functions on the monitor.

PICTURE

Set the color and brightness on the monitor.

NORMAL/MIRROR

Input video can be reversed

AUDIO

Set the audio ON/OFF.

TRIGGER AUDIO

Set the audio ON/OFF when entering the TRIGGER signal.

CAMERA TRIGGER

You can adjust the Screen settings with the corresponding TRIGGER signal is on.

DISTANCE MARKER

DISTANCE MARKER can be set according to the TRIGGER signal input.

AUTO PICTURE SCAN

Set the automatic sequence switching time.

CAMERA NAME

Set the camera name.

SPEED SWITCH

By receiving TACHO signal, you can set the operation at the corresponding frequency.

SPLIT

Display the camera video at the set position on the SPLIT screen.

MANUAL SELECTION

When the SELECTION button is pressed, the output screen is set.

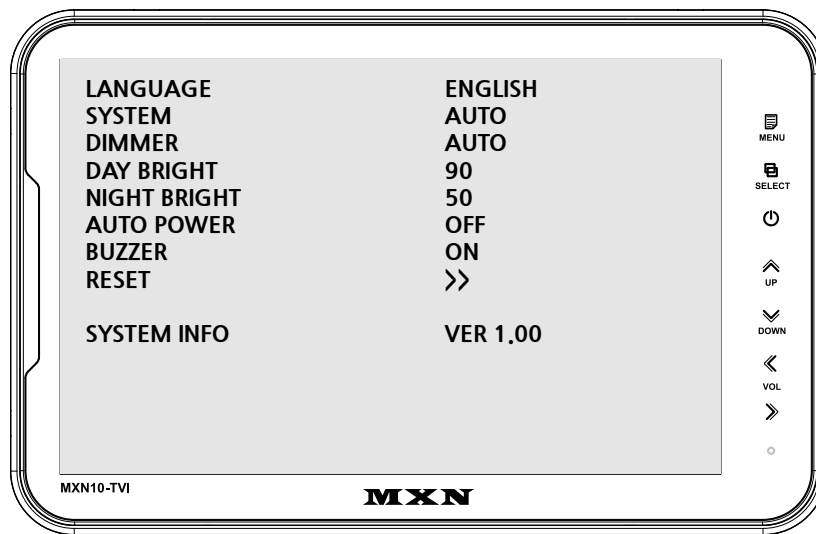

FUNCTION

LANGUAGE

Provide 6 Multi-lingual OSD [ENGLISH, SWEDISH, DANISH, NORWEGIAN, DUTCH, FINNISH].
Select the preferred LANGUAGE.

SYSTEM

Select AUTO/TVI/AHD/NTSC/PAL

DIMMER (Automatic Brightness Control)

Select AUTO or OFF to enable Automatic or Manual brightness control.

REMARK: By activating the DIMMER AUTO function,
the monitor adjusts the brightness according to the environment.

DAY BRIGHT

Select the DIMMER as 『AUTO』, set the value of backlight on DAY mode(0~100).

NIGHT BRIGHT

Select the DIMMER as 『AUTO』, set the value of backlight on NIGHT mode(0~100).

AUTO POWER

Select monitor activation functions as below.

[AUTO] The monitor remembers the last settings from its memory.

[ON] The monitor is turned on with the 『Power-ON』 mode automatically.

[OFF] The monitor is turned on with the 『Stand-By』 mode automatically.

BUZZER

Select BUZZER sound 『ON』 and 『OFF』.

RESET

Press “>>” button to enter the factory default settings.

SYSTEM INFO

Refers to the system information of the monitor.

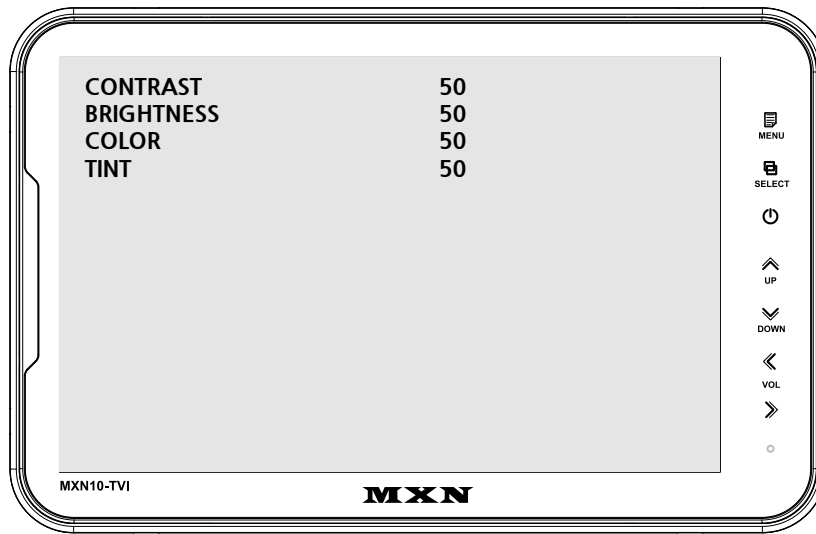

PICTURE MENU

Press [LEFT/RIGHT] button to adjust the PICTURE of the monitor.

PICTURE MENU is for the settings of PICTURE from CAM1, CAM2, CAM3, SPLIT MODE.

FISHEYE

When using the FISHEYE camera, 『ON』 will calibrate the screen on the FULL screen.

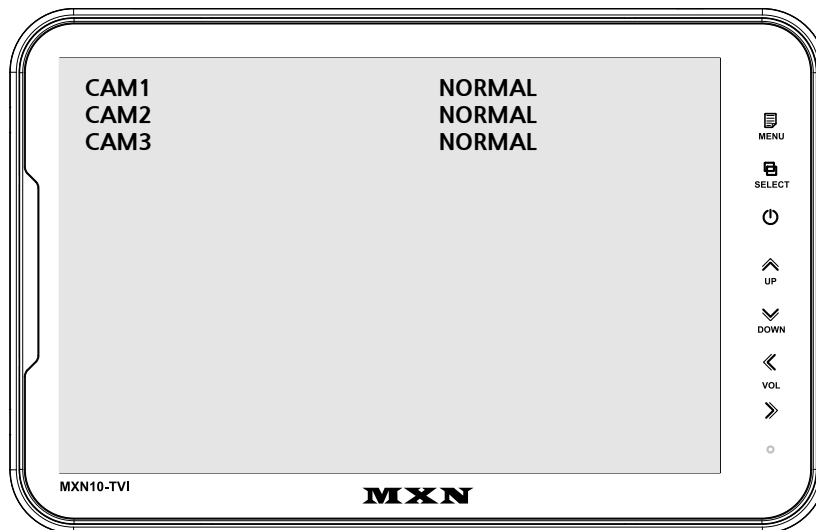

NORMAL/MIRROR

Each camera picture (CAM1/CAM2/CAM3) can be switched between NORMAL& MIRROR image.



AUDIO

Audio ACTIVATED Mode in normal mode.

When the mode is [ON], audio will be on (activated)

When the mode is [OFF], audio will be off (mute).

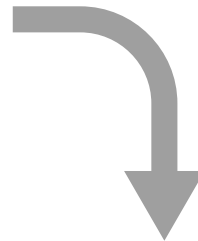
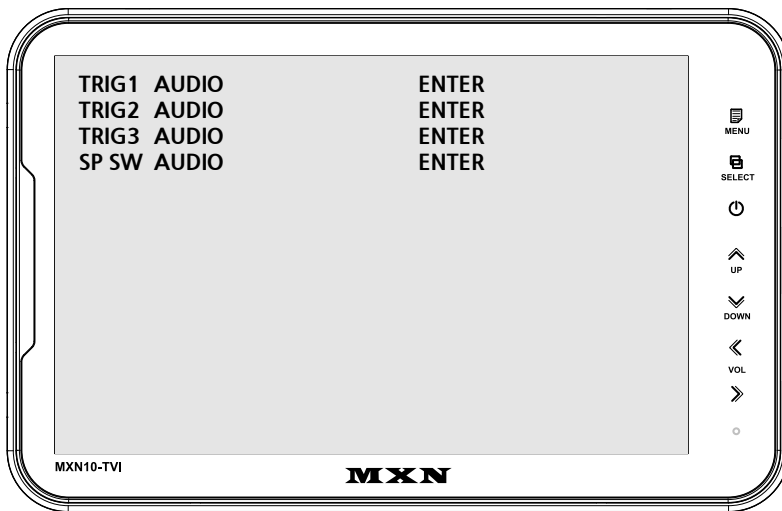

TRIGGER AUDIO

Audio ACTIVATED Mode in Trigger mode.

Choose the trigger and then press [ENTER].

The Audio settings menu will be shown as below.

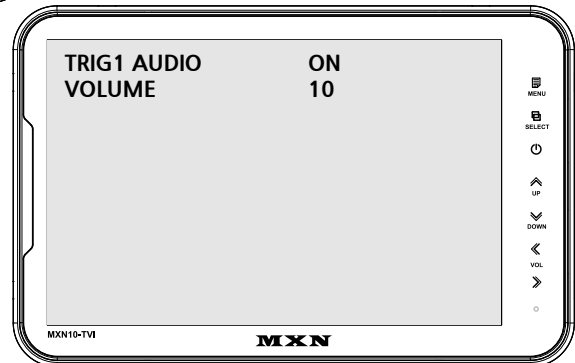

When the mode is [ON], audio will be on (activated).

When the mode is [OFF], audio will be off (mute).

The user can adjust the volume.

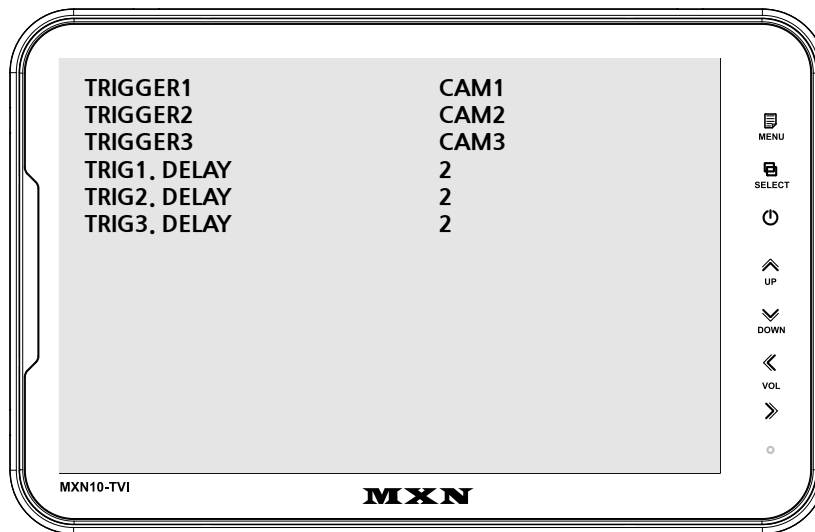

CAMERA TRIGGER

TRIGGER 1/2/3 (Trigger source selection)

Select the required trigger source at CAM1/CAM2/CAM3/SPLIT

REMARK

TRIGGER PRIORITY: TRIGGER 1 > TRIGGER 2 > TRIGGER 3

TRIG. DELAY

When a TRIGGER wire is connected to a pulse DC power signal (e.g. direction indicator lights) then the [TRIGGER DELAY] function avoids repeating ON/OFF of the monitor.

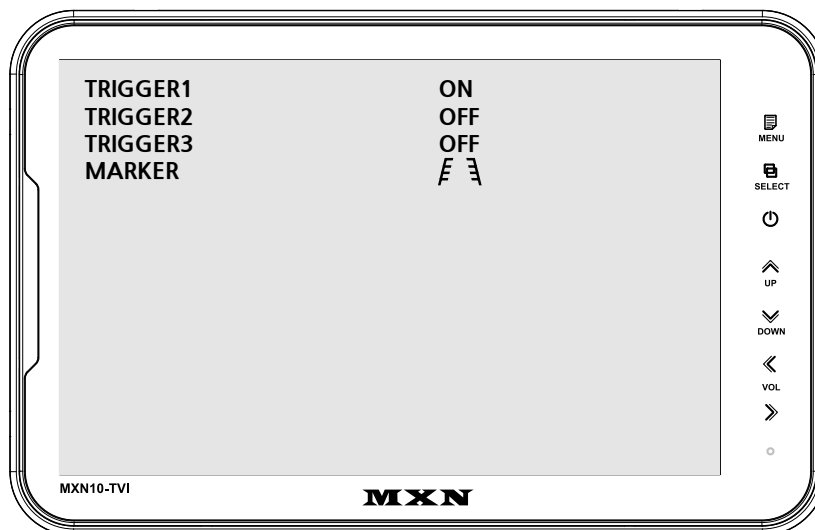

DISTANCE MARKER

Select ON to have DISTANCE MARKER for CAM1, CAM2, CAM3
DISTANCE MARKER is displayed as the trigger signal is activated.

MARKER

Select of DISTANCE MARKER. ☞ ☜ or ____

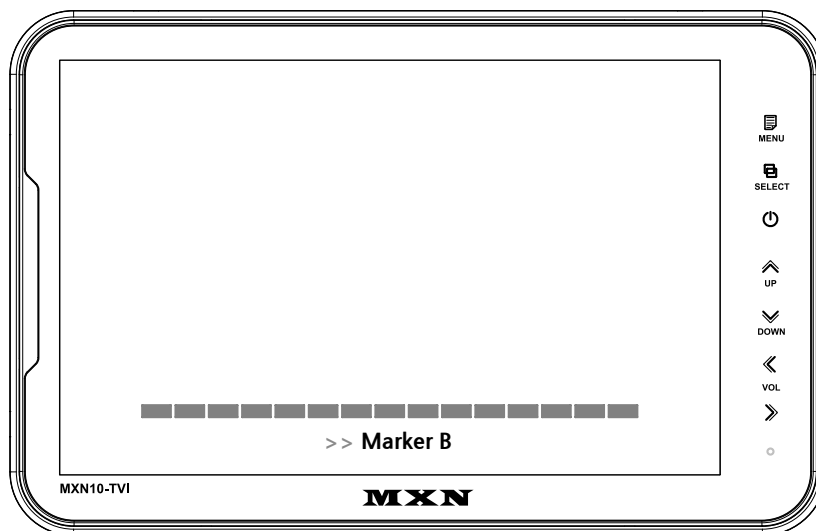
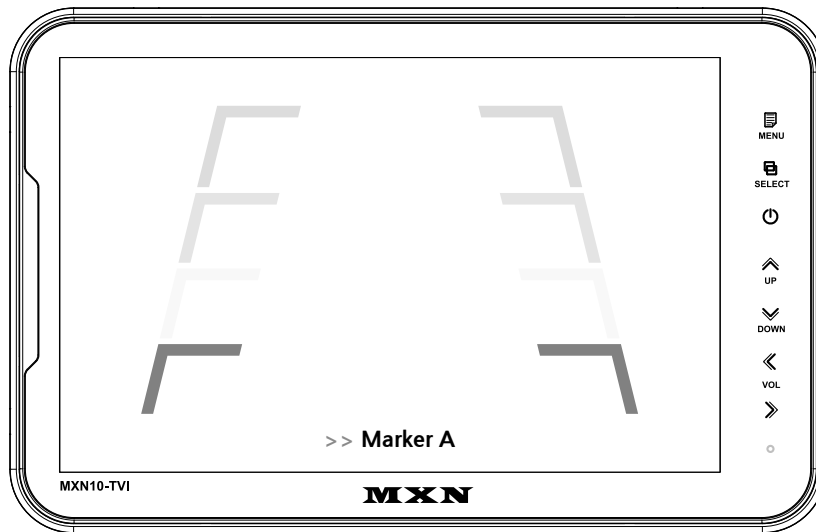

DISTANCE MARKER ADJUSTMENT

Users can make adjustments by pressing the SELECT button in the menu.
(It is not available on the split mode screen)

Marker A- Parking line

The left/right/both markers will be selected in order each time you press the SELECT button. When the marker is red it can be adjusted UP/DOWN or LEFT/RIGHT.

When both distance markers are RED, you can adjust both markers LEFT/RIGHT/UP/DOWN. When the left distance marker is RED, the left marker can be adjusted LEFT/RIGHT. When the right distance marker is RED, the right marker can be adjusted LEFT/RIGHT.

Marker B- Horizontal line

Users can adjust the line UP/DOWN.

Users can adjust the horizontal line by pressing [UP/DOWN] buttons.

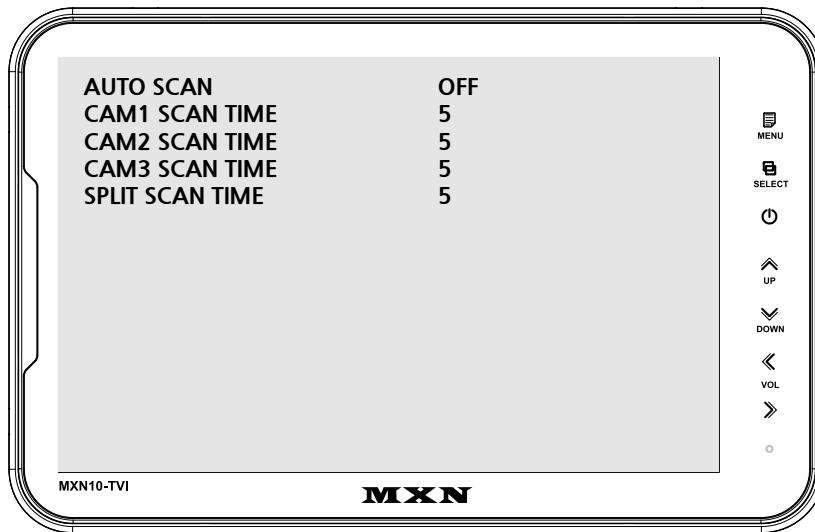

AUTO PICTURE SCAN

Each scanning time of CAM1/CAM2/CAM3/SPLIT can be managed.

REMARK

If the SCAN TIME is set as [0], monitor skips its channel during scanning.
Press [UP] button for 4 seconds to ACTIVATE / INACTIVATE auto scanning function.

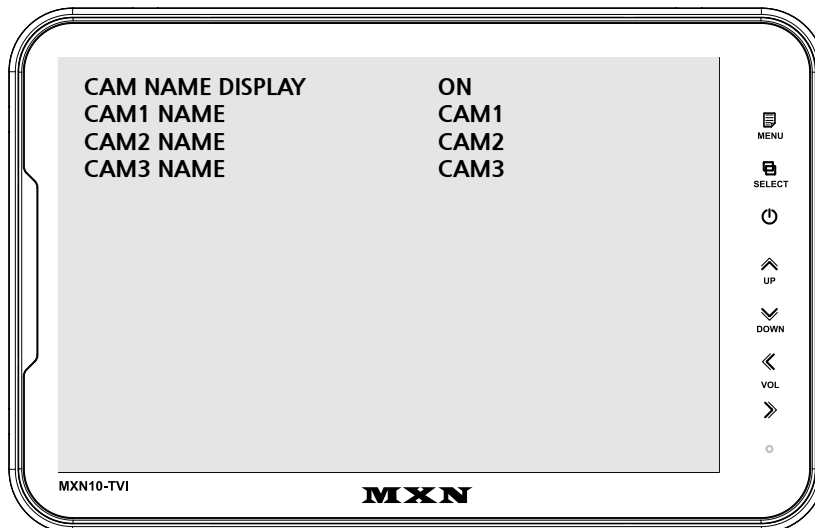

CAMERA NAME

CAMERA NAME can be selected as CAM1, 2, 3/REAR/LEFT/RIGHT/FRONT.

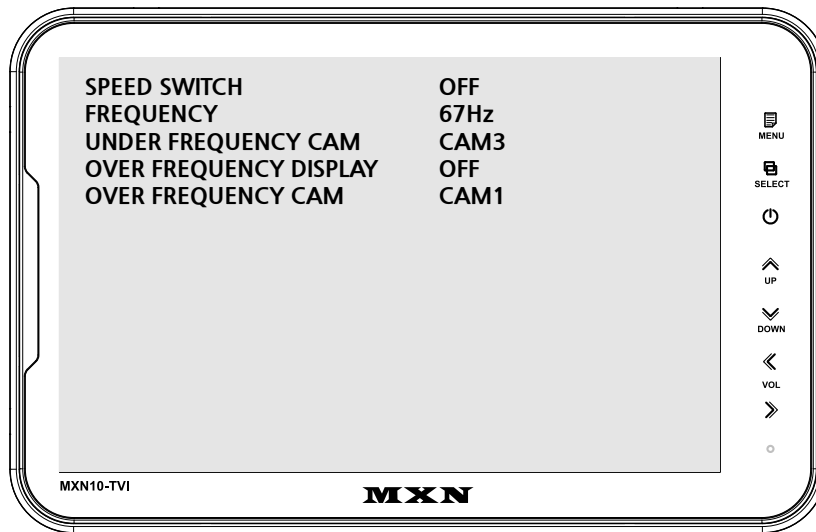

SPEED SWITCH

The orange wire needs to be connected with the vehicle's tacho signal and via MENU the SPEED SWITCH needs to be selected ON. At FREQUENCY 67Hz setting (and the most common used tacho signal) the selected camera will be displayed during a speed of 0~33km/h. Select the concerning camera via 『UNDER FREQUENCY CAM』 (At a different type of tacho signals the FREQUENCY needs to be adjusted higher or lower than the example)

Over 33km/h (72Hz) the selected camera will be switched OFF automatically. When the speed slows down, then the selected camera will be switched ON automatically again at 30km/h. Instead of automatic switch OFF at a speed over 33km/h it is also possible to activate another video source, such as a navigation picture from an optional navigation computer. In this case user needs to select 『OVER FREQUENCY DISPLAY: ON』 and user needs to select 『OVER FREQUENCY CAM』

In case of TRIGGER activation during 『SPEED SWITCH ON』 mode, then TRIGGERS 1 ~ 3 will overrule the 『SPEED SWITCH』 function.

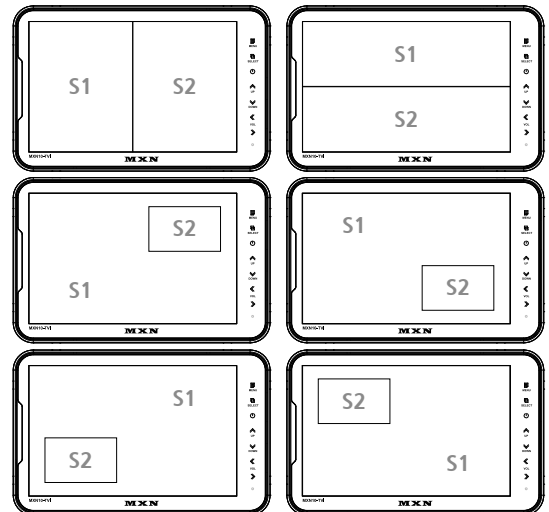
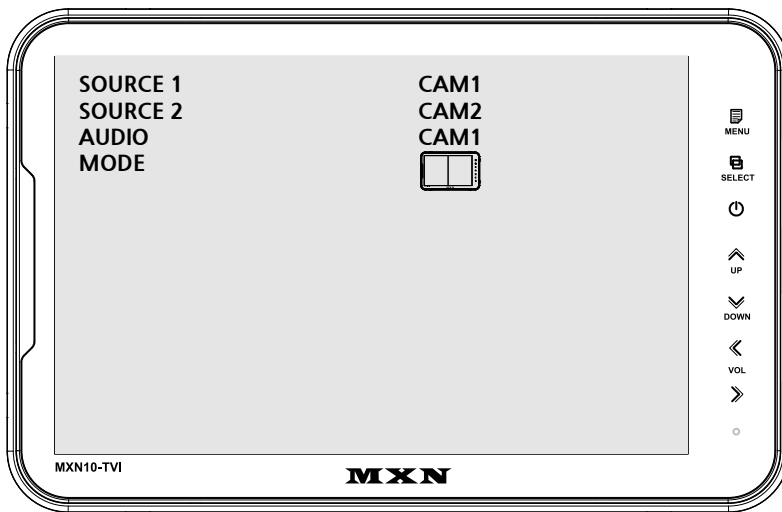

SPLIT configuration

- SOURCE 1 Select S1 Camera (CAM1~CAM3).
- SOURCE 2 Select S2 Camera (CAM1~CAM3).
- AUDIO Select SPLIT of Audio (CAM1~CAM3).
- MODE Select SPLIT MODE

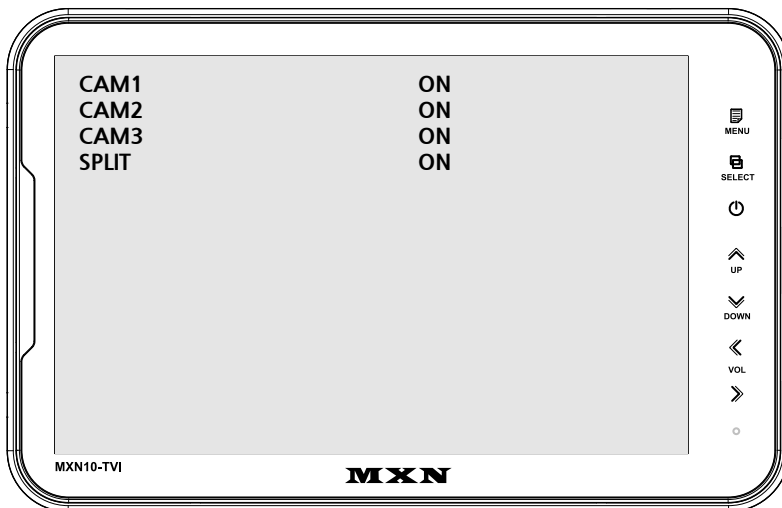

MANUAL SELECTION

When you manually press the channel select button, only the camera selected ON and the display mode selected ON are displayed.

Manually pressing the channel select button skips the camera selected OFF and display mode selected OFF.

[NOTE]

Triggers neglect the MANUAL SELECTION settings. In case of Trigger activation, these ON/ OFF settings will be ignored.

MENU LOCK ON/OFF FUNCTION

LOCK ON/OFF FUNCTION

The setup menu can be locked to ban any unauthorized users.

LOCK ON mode

At the Power-ON mode, press the [DOWN] button for 10 seconds to activate the LOCK ON function. When [LOCKED] is displayed on the screen, the user can use only [POWER, SELECT, VOLUME] buttons and the user can edit settings for the PICTURE menu.

LOCK OFF mode

At the Power-ON mode, press [DOWN] button for 10 seconds to activate the LOCK OFF function. When [UNLOCKED] is displayed on the screen, the user can use all the functions of the setup menu.

SCAN ON/OFF FUNCTION

At the Power-ON mode,
press the [UP] button for 4 seconds to activate the Auto Scan Picture function.
During the Auto Scan Mode,
press the [UP] button for 4 seconds to deactivate Auto Scan Picture function.



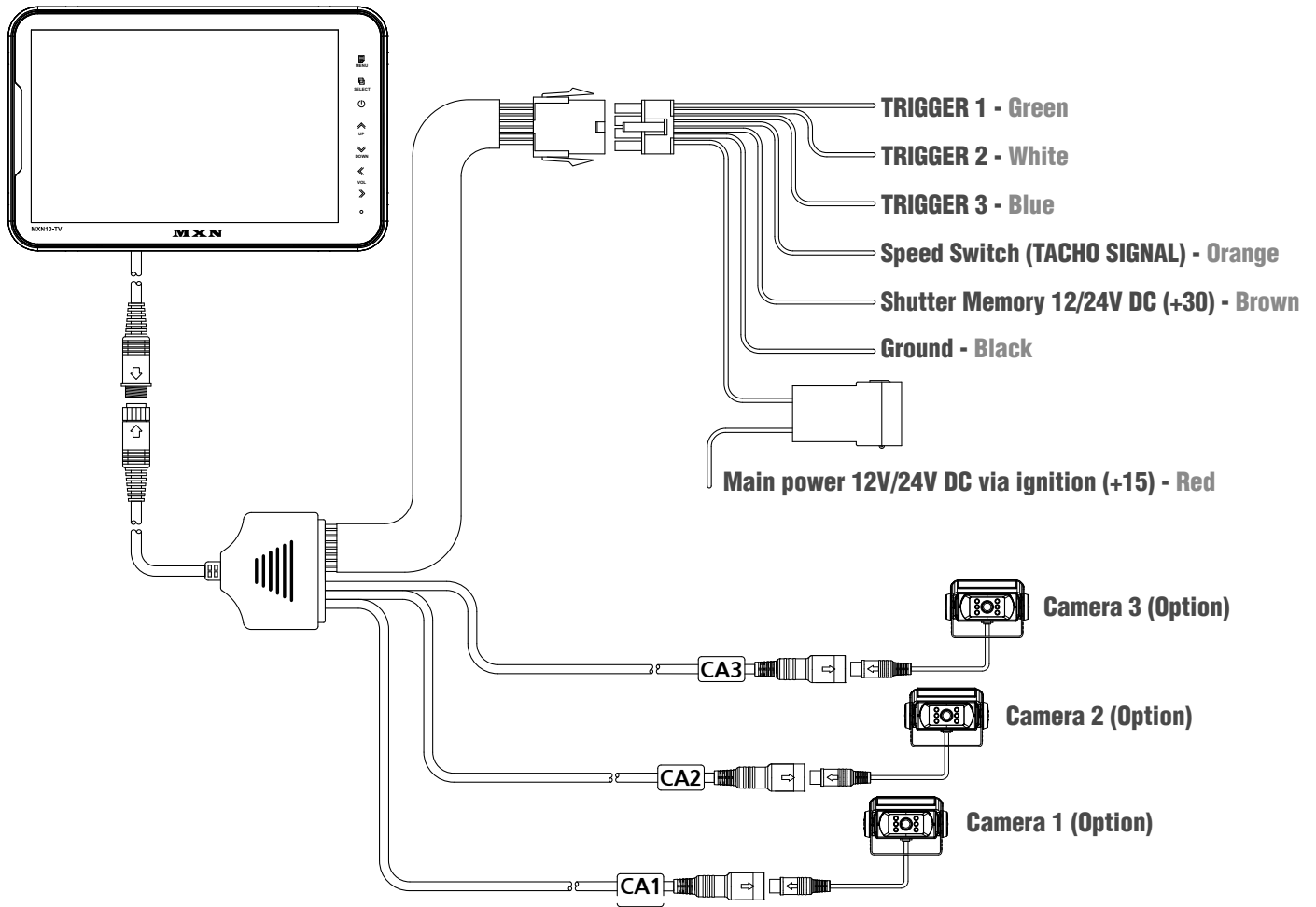

CAMERA INPUT

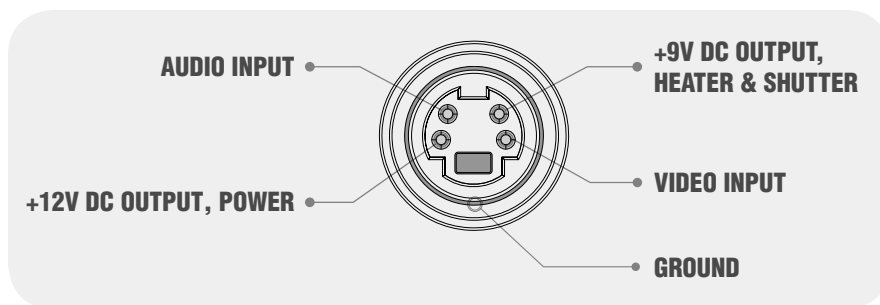

SHUTTER MEMORY FUNCTION

The function of "Shutter Memory" wire (brown wire) is to close the shutter of shutter camera when Main +DC Power (+15) at the monitor's red wire is disconnected while the camera's shutter is OPEN.

The "Shutter Memory" wire does not drain any current from the vehicle's battery within several seconds after the camera's motorized shutter(s) are closed.

MONITOR installation with Standard Heavy Duty Mount Bracket

Fix the supplied Heavy Duty Mount Bracket into the monitor with the included screws. Heavy Duty Mount Bracket's angle fixation can be adjusted by tightening knobs.

[NOTE]

- The screw type : Mount-screw type, M5 (diameter of 5mm).
- The length of screw : Max. 12mm.
- Screw thread : 0.8mm.

Please make it sure to use the proper screws in order to avoid any damage into the monitor.

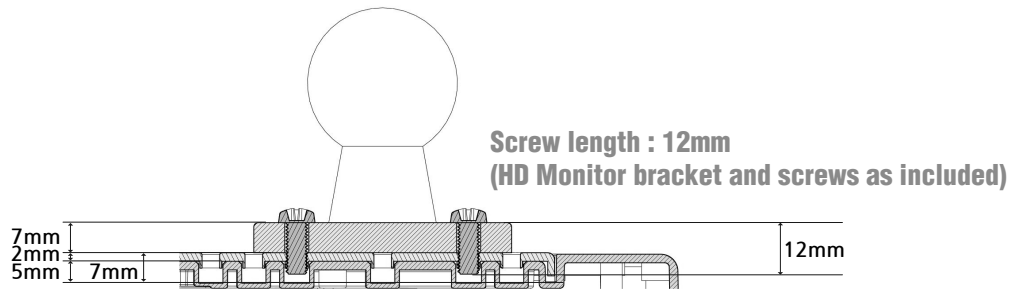

[NOTE]

Maximum 7mm insert of screw into the monitor in case another type bracket and/or screws are being applied. A deeper insert than 7mm will damage the monitor.

Heavy Duty Mount Bracket

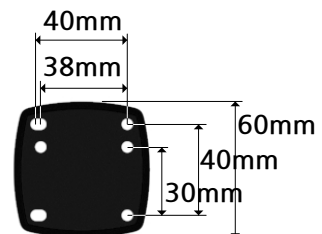
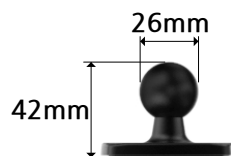
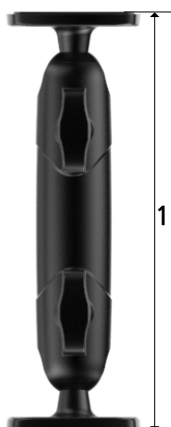
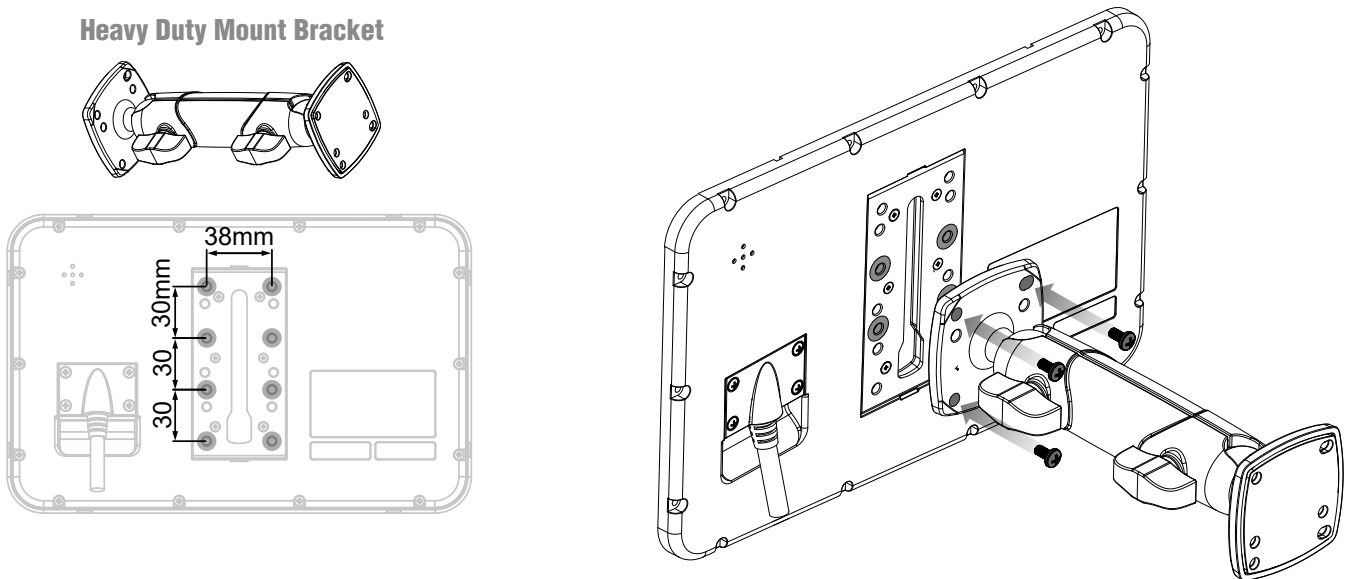

Installation of Heavy Duty Mount Bracket

The MONITOR can be used with different types of HEAVY DUTY MOUNTING BRACKETS. Please check the availability in advance, then please follow the instructions as below.

[NOTE]

- The screw type : Mount-screw type, M5 (diameter of 5mm).
- The length of screw : Max. 12mm.
- Screw thread : 0.8mm.

Please make it sure to use the proper screws in order to avoid any damage into the monitor.

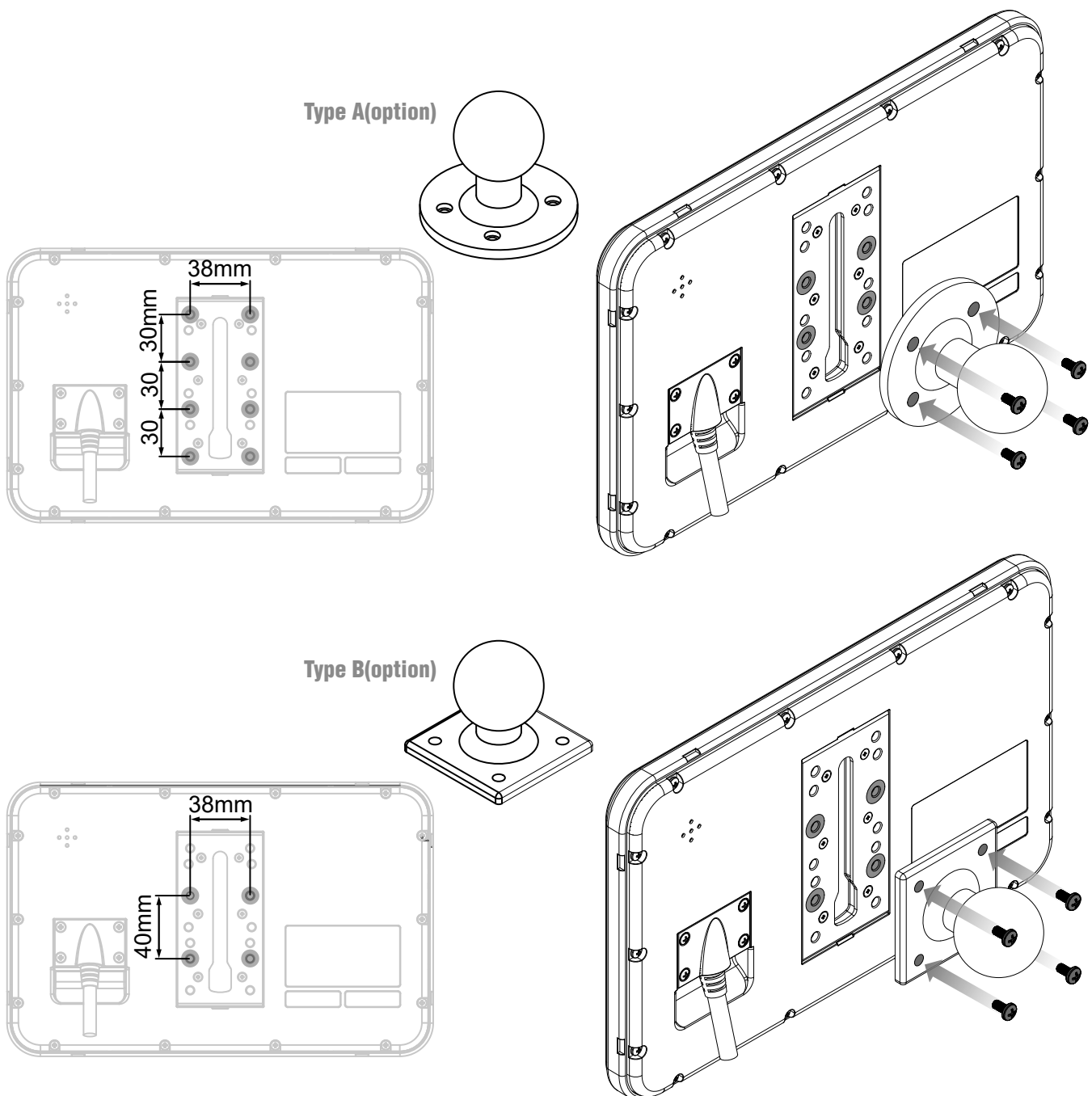

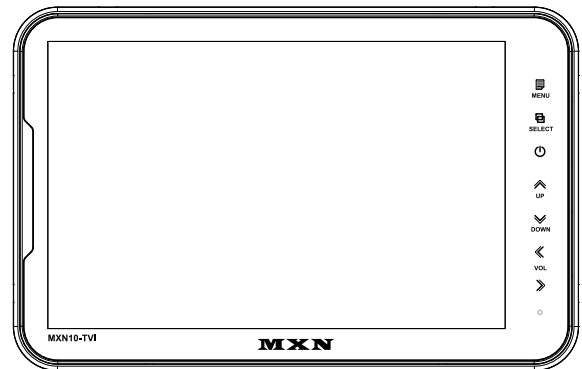

ITEM SPECIFICATIONS

LCD SCREEN SIZE	10.1 Inch Wide IPS Digital TFT LCD Panel	
DIMENSIONS	270(W) x 174(H) x 20(D) mm	
DISPLAY DIMENSIONS	216.96 X 135.6 mm	
POWER INPUT	DC 10V ~ 32V	
POWER CONSUMPTION	Max. 15W	
VIDEO SYSTEM	HD-TVI (25fps, 30fps, 50fps, 60fps), AHD (25fps, 30fps) CVBS-PAL, CVBS-NTSC	
SYNC. SYSTEM	Internal	
BRIGHTNESS	350cd/m2	
DISPLAY RESOLUTION	WXGA, 1280 X (RGB) X 800	
VIEWING ANGLES	178° horizontal / 178° vertical	
COLOR CONFIGURATION	RGB Stripe	
DIMMER	Automatic / Manual	
SPEAKER IMPEDANCE	Max. 8Ω / 1W	
OPERATING TEMP.	-20°C to + 70°C	
STORAGE TEMP.	-30°C to + 80°C	
IMPACT RATING	5G	
CAMERA CONNECTOR	4-Pin mini DIN (MXN configuration)	
HOUSING	Light Black (ABS)	
ON-SCREEN DISPLAY CONTROL FUNCTIONS	<ul style="list-style-type: none"> ■ Volume ■ Color ■ CAM 1/2/3, Split ■ Speed Switch ■ Distance Marker ■ Dimmer ■ Reset 	<ul style="list-style-type: none"> ■ Brightness ■ Contrast Tint ■ CAM Trigger 1/2/3 ■ Auto Power ■ Auto Picture Scan ■ Language
SUPPLIED ACCESSORIES	Bracket -1 pce / Screw Kit -1set / Manual / Multi-cable-1 set	
WEIGHT	± 850g (excluding bracket)	

OWNER'S MANUAL

PLEASE READ CAREFULLY BEFORE
USING THIS PRODUCT.

10.1" DIGITAL 3CH LCD ALL ROUND VISION MONITOR

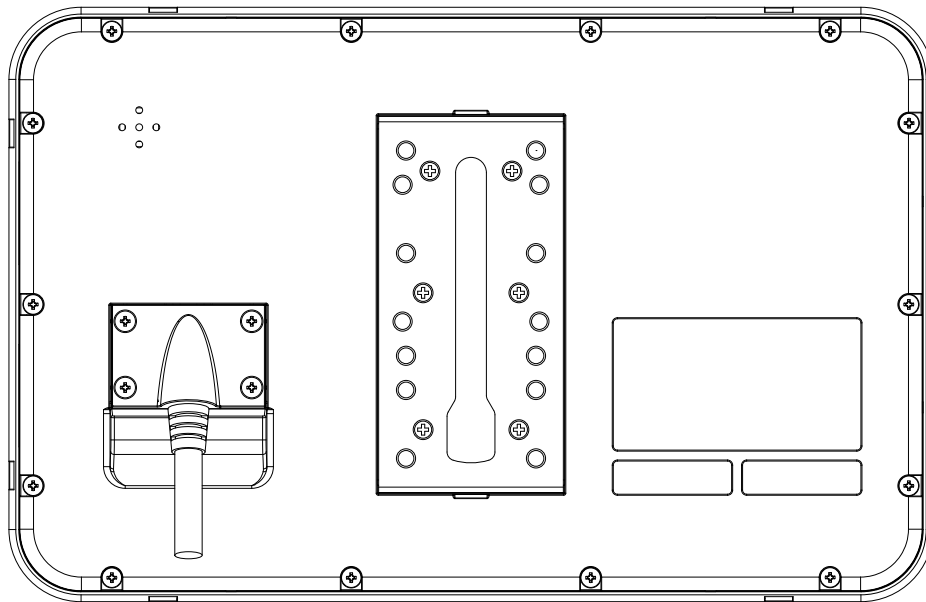

Model: MXN10-TVI

Design and specifications are subject to change without notice.